

WELCOME

PARKHILL ROAD WEST RECONSTRUCTION
PUBLIC OPEN HOUSE

WELCOME TO THE CITY OF PETERBOROUGH PUBLIC OPEN HOUSE FOR THE RECONSTRUCTION OF PARKHILL ROAD WEST PHASE 3: 250m WEST OF RAVENWOOD DRIVE TO CITY LIMITS

**April 24, 2019
4:30 - 6:30pm**

Please Sign in at the Front Table

Please take a comment sheet to record your thoughts as you review the display materials.

City of Peterborough staff and the WILLS design team are available to discuss any questions or concerns that you may have.



PHASE 3 OVERVIEW

PARKHILL ROAD WEST RECONSTRUCTION PUBLIC OPEN HOUSE

1. Improvements to Parkhill Road were identified in the Environmental Assessment Study approved in April 2012.
2. Improvements to Parkhill Road under Phase 3 Include:
 - Two traveled lanes, with bike lanes
 - Revised vertical alignment
 - Sidewalks and multi-use pathways
 - Left turn lanes and traffic signals at Chandler Cres.
 - Roundabout at intersection of Brealey/Ackison/Parkhill
 - Curb and gutter
 - Storm sewer
 - New storm outlet at Jackson Creek Tributary
 - Tree planting program
3. Property acquisition was required in order to increase the width of the public road allowance from 20m to 30m at previously identified locations.
4. Tree removals and utility relocations are required to facilitate the work and are on-going.

Please refer to the OVERALL plan for an illustration of the anticipated phases of construction



PHASE 3 ROADWAY CROSS SECTIONS

PARKHILL ROAD WEST RECONSTRUCTION
PUBLIC OPEN HOUSE

PARKHILL ROAD WEST

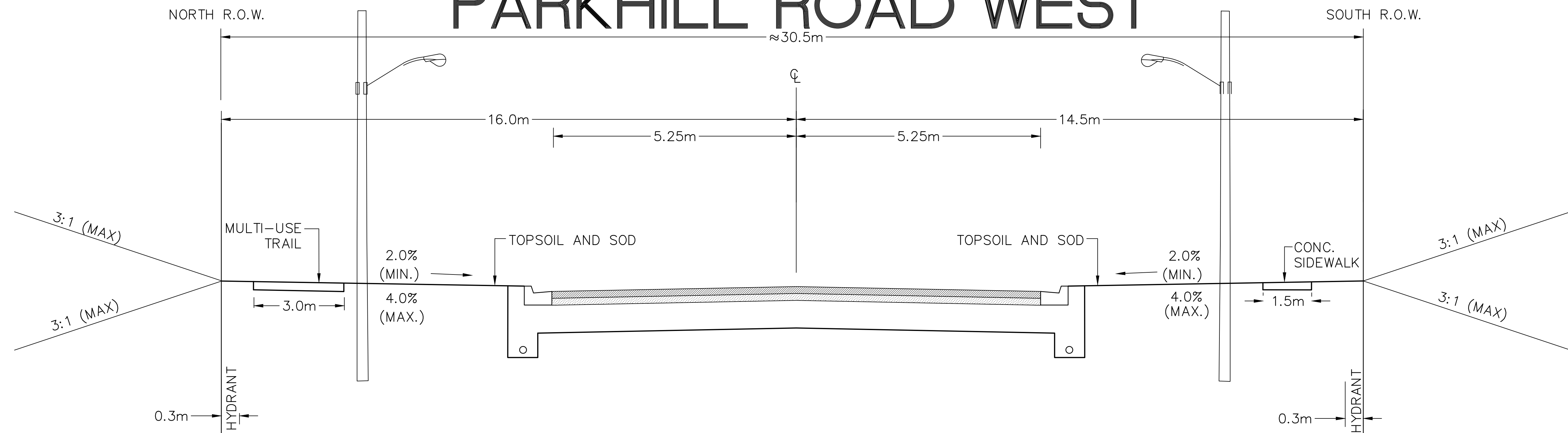

BREALEY DRIVE/ACKISON ROAD

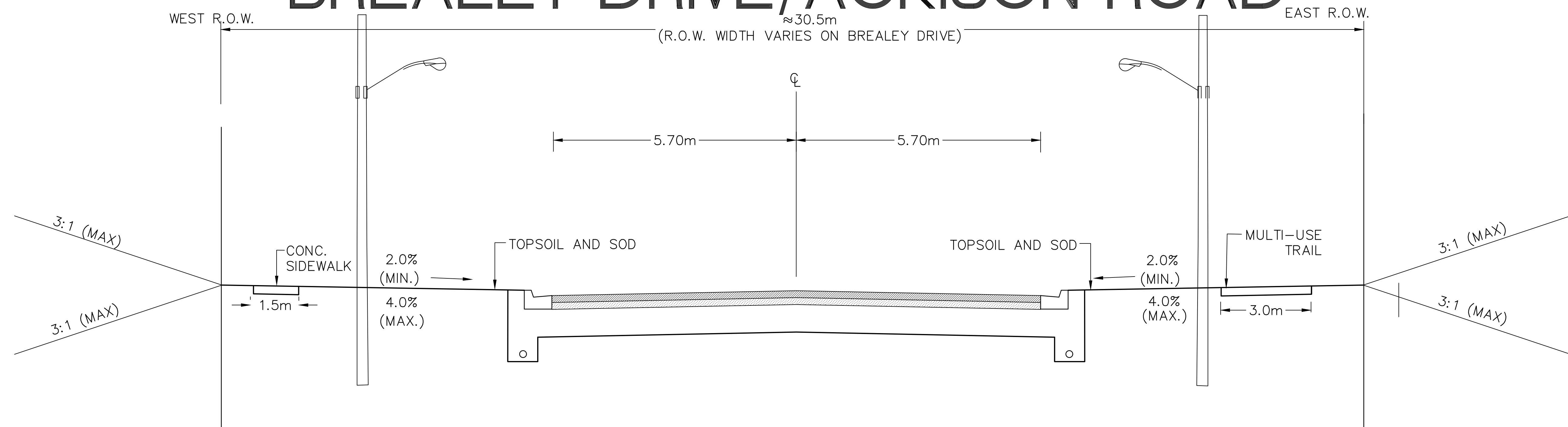

PHASE 3: STAGING

PARKHILL ROAD WEST RECONSTRUCTION PUBLIC OPEN HOUSE

STAGE 1: 1268 PARKHILL RD. W. TO EAST SIDE OF CHANDLER CRES. INTERSECTION

- Road widening and intersection improvements
- New/upgraded sanitary and storm sewers
- Utility relocation
- New sidewalk and multi-use trail
- Completed 2019

STAGE 2: EAST SIDE OF CHANDLER INTERSECTION TO 1194 PARKHILL RD. W.

- Road widening including new sidewalk and multi-use trail
- New sanitary and storm sewers
- Completed 2019

STAGE 3: 1268 PARKHILL RD. W. TO WEST CITY LIMIT (INCLUDING ROUNDABOUT, BREALEY DR. AND ACKISON RD.)

- Road widening including new sidewalk and multi-use trail
- New sanitary and storm sewers, new storm sewer outlet
- Realignment of Brealey Dr. and construction of roundabout intersection
- Completed 2020

STAGE 4: ENTIRE PROJECT AREA

- Final paving
- Activation of traffic signals and street lighting
- Remaining boulevard work
- Completed 2020



PHASE 3 OVERVIEW

PARKHILL ROAD WEST RECONSTRUCTION

PUBLIC OPEN HOUSE

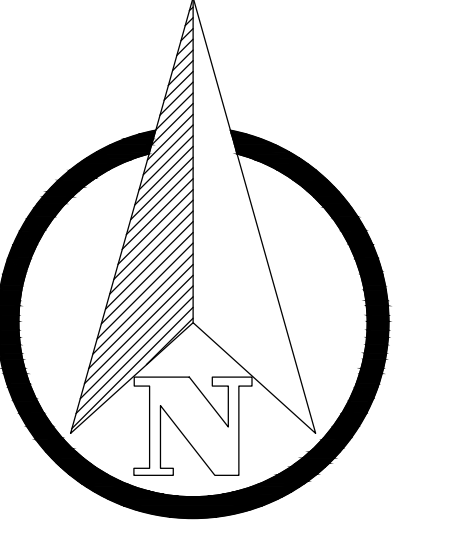

STAGE 1

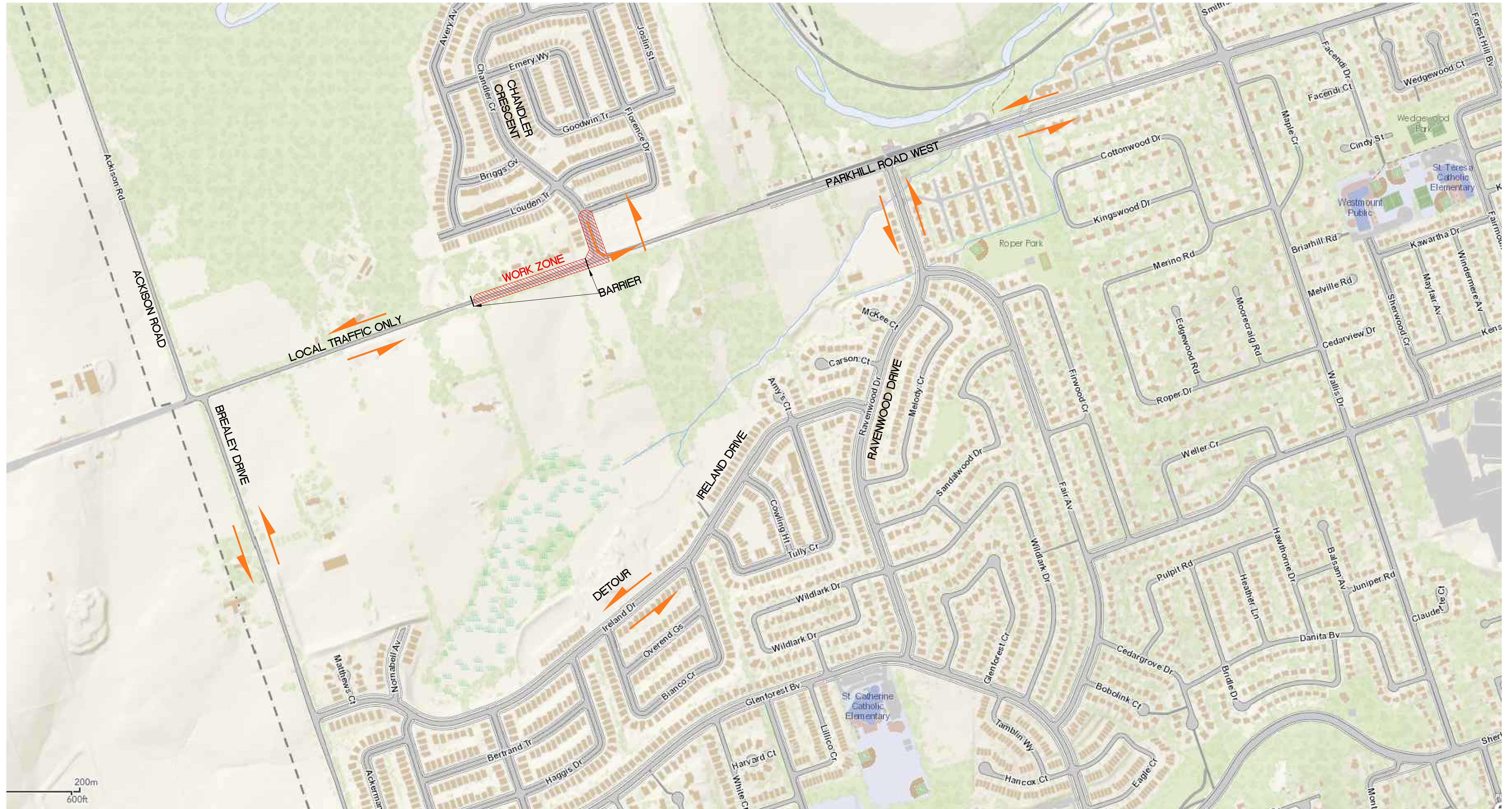

PHASE 3 OVERVIEW
PARKHILL ROAD WEST RECONSTRUCTION
PUBLIC OPEN HOUSE

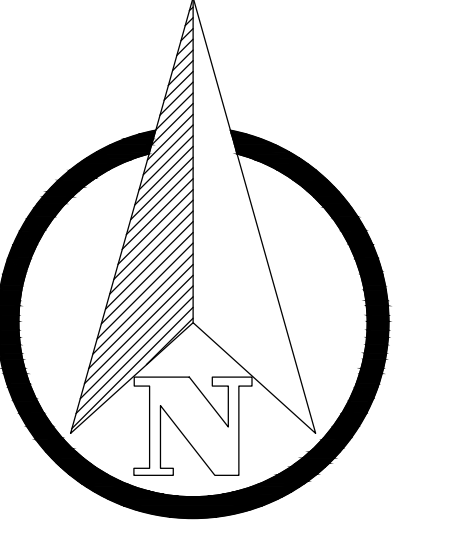

STAGE 2

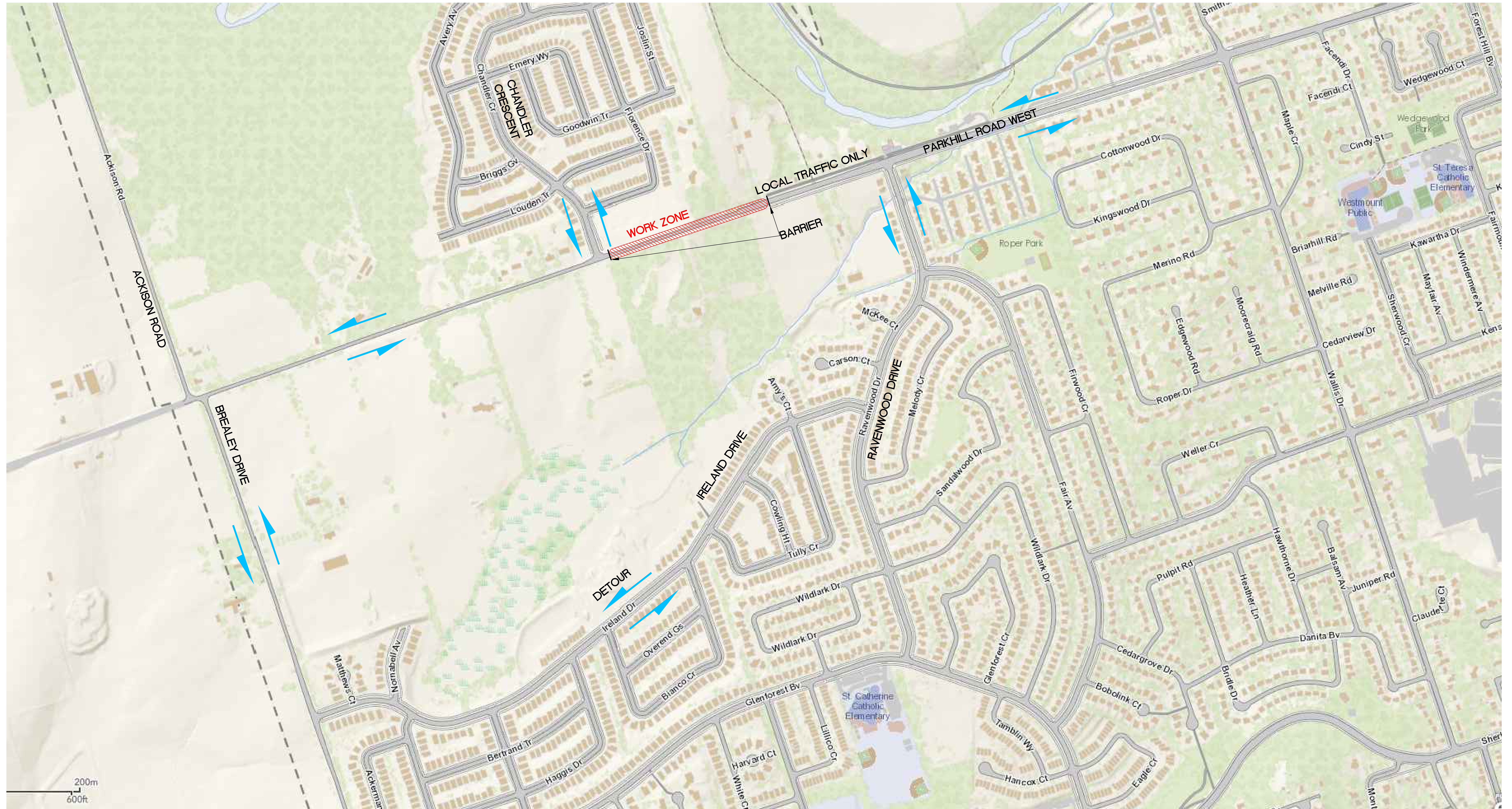

PHASE 3 OVERVIEW

PARKHILL ROAD WEST RECONSTRUCTION

PUBLIC OPEN HOUSE

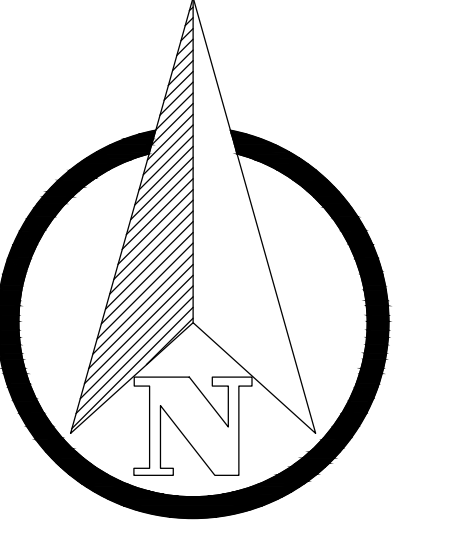

STAGE 3

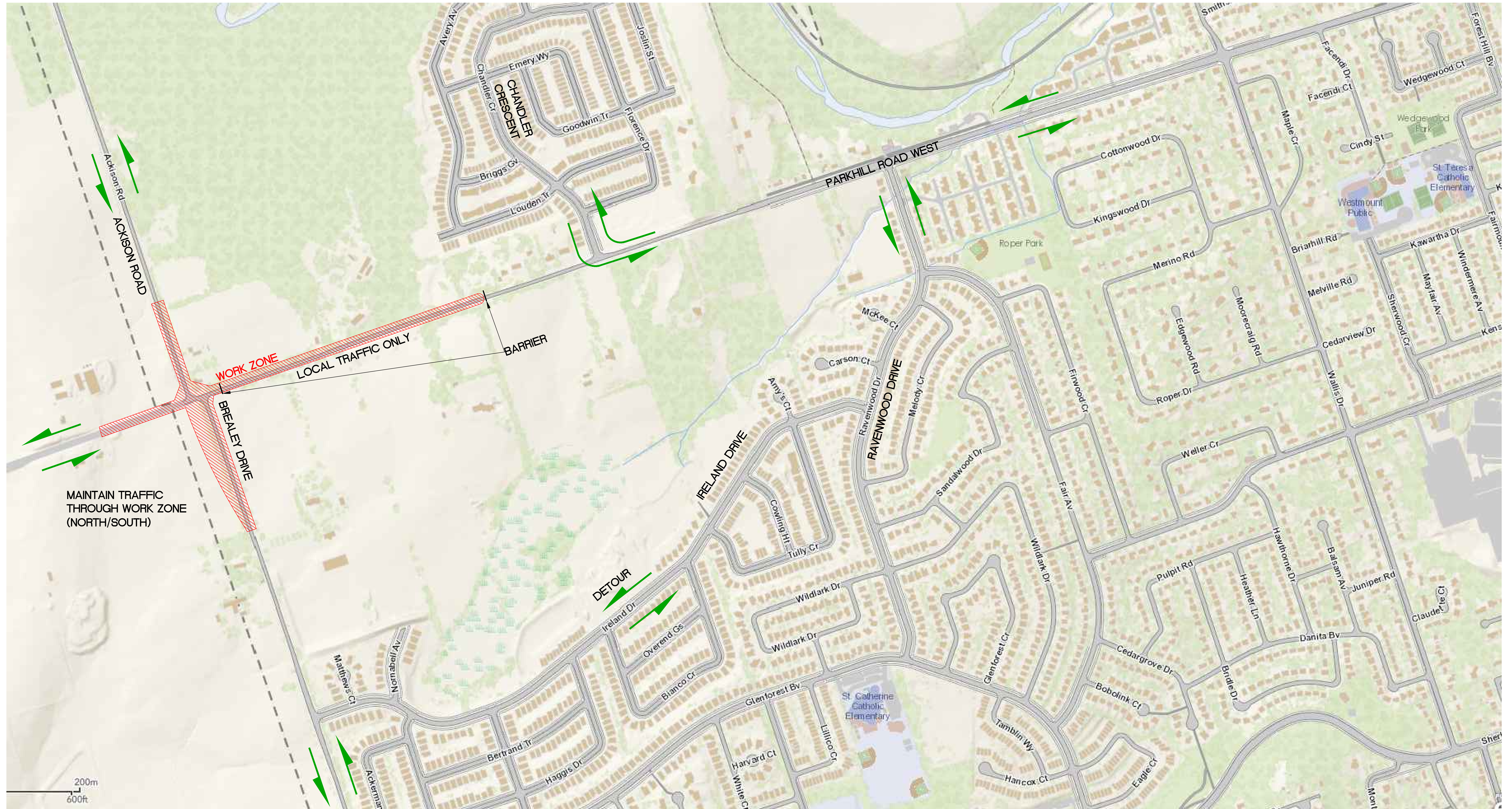

PROJECT CONTACTS

PARKHILL ROAD WEST RECONSTRUCTION
PUBLIC OPEN HOUSE

THANK YOU FOR ATTENDING!

Comment Sheets are available should you have additional questions regarding the project.

D.M. Wills Associates Limited

David Bonsall, P.Eng.

Project Manager

150 Jameson Drive, Peterborough, ON K9J 0B9

Phone: 705-742-2297 Ext. 240 Fax: 705-741-3568

Email: dbonsall@dmwills.com

City of Peterborough

Greg Giles, C.E.T.

Engineering Services Coordinator

500 George Street North, Peterborough, ON K9H 3R9

Phone: 705-742-7777 Ext. 1711 Fax: 705-876-4621

Email: ggiles@peterborough.ca

